

**OpenPlant**

sharing tools for a sustainable future

# SynBio 4 Schools



Biotechnology and  
Biological Sciences  
Research Council

# SynBio 4 Schools

SynBio 4 Schools is an OpenPlant project that aims to inspire and educate the next generation of biological engineers.



# TABLE OF CONTENT

**04** Introduction to SynBio 4 Schools

**06** What is synthetic biology

**08** Building DNA Circuits  
- construct gene circuits to solve problems

**12** Generating electricity from plants  
- build a plant microbial fuel cell (pMFC)

**17** What can viruses do for you?  
- build virus structures

**21** Natural product synthesis  
- match organisms and natural products

**27** Supplementary materials

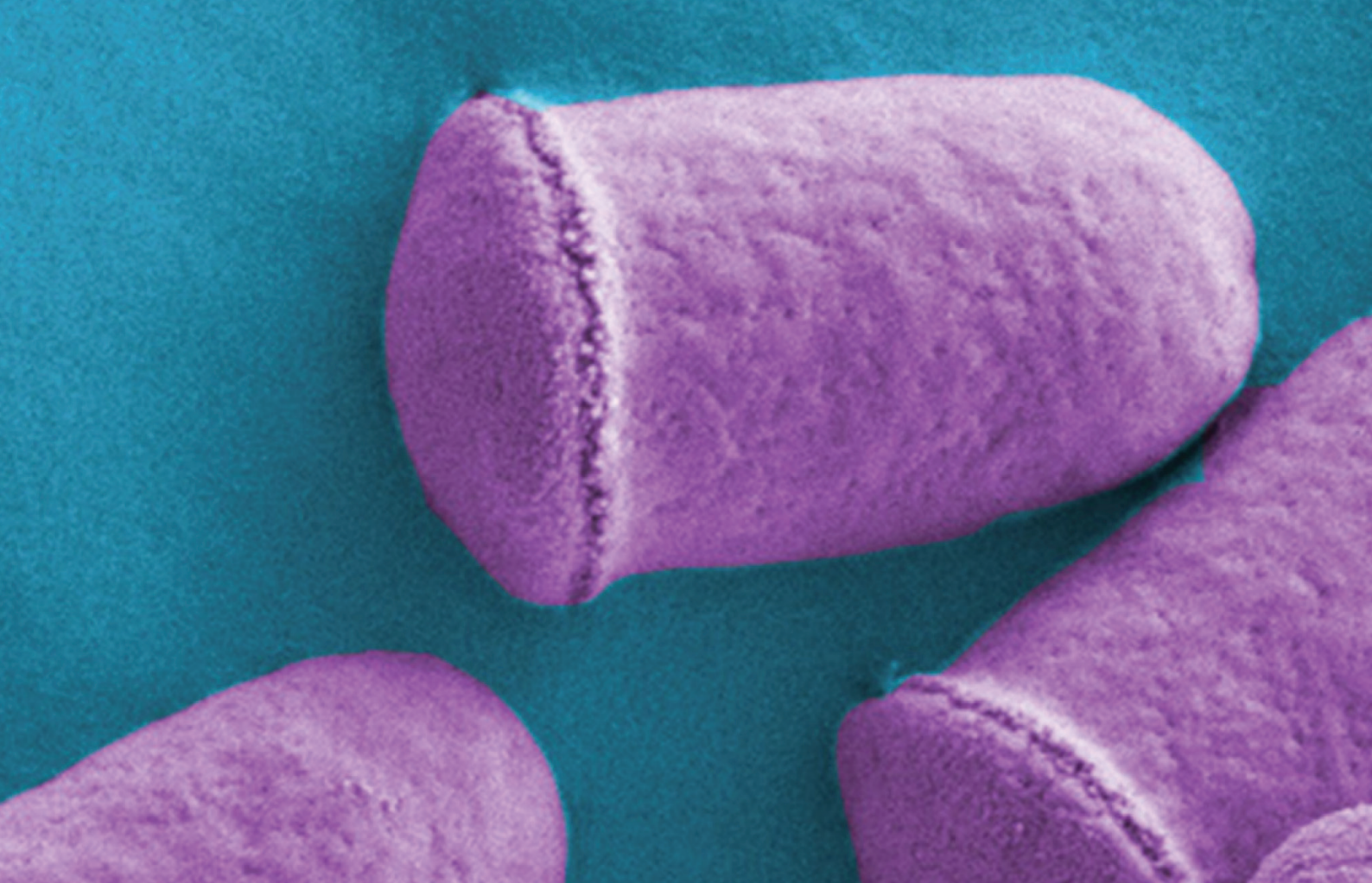

# SynBio 4 Schools

The SynBio 4 Schools project aims to complement the national curriculum and existing teaching resources by providing activities that cover under-represented topics in plant synthetic biology.

Synthetic biology is an emerging and important multidisciplinary field that is currently under-represented in the national curriculum and teaching resources. Based around OpenPlant research from

Cambridge, Norwich and beyond, this booklet contains practicals and lessons for GCSE and A-level students that teach the principles of synthetic biology, with a focus on plant science.

---

## Synthetic biology practicals with a focus on plant science

---



Adjustable practical guides for different age groups and abilities



---

Supplementary articles, case studies and resources that help put practicals into a real-world context



---

Supporting materials for teachers, such as links to publications and additional resources

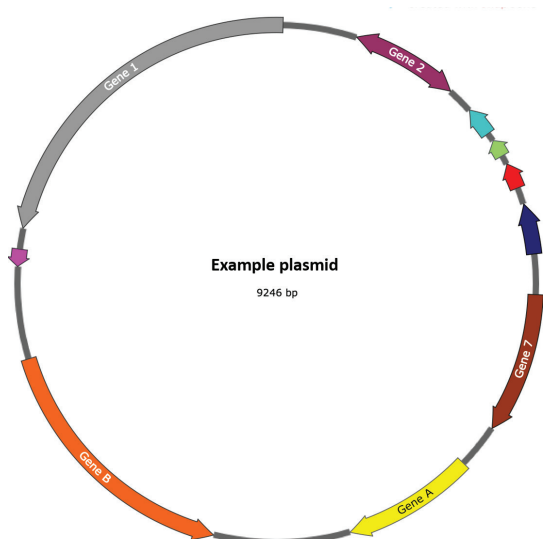

---

This edition of the SynBio 4 Schools booklet contains guides to the following activities:

- **Building DNA Circuits**
- **Generating electricity from plants**
- **What can viruses do for you?**
- **Natural product synthesis**

# What is synthetic biology?



Synthetic biology is an emerging interdisciplinary field that applies engineering principles to biology, to create new or redesign already existing products, systems and devices. It encompasses a wide range of methodologies from various disciplines such as; computing, biochemistry, systems biology, genetic engineering and many more.

---

Synthetic biology tools are now used to produce and improve biofuels, chemicals and medical technologies, as well as assist with nature conservation.

Examples include the partial synthesis of the malaria fighting compound artemisinin, at an industrial scale using *Escherichia coli* (*E.coli*) and the production of biofuels from yeast.

The possibilities of synthetic biology are seemingly endless, with many opportunities to explore.

# Applications



## Some goals of Synthetic Biology

### STANDARDISED BIOLOGICAL PARTS

Identify standardised genomic parts that can be used to build novel biological systems.

### PROTEIN DESIGN

Expand on the functions of natural proteins.

### NATURAL PRODUCT SYNTHESIS

Prepare a target molecule such that the products are analytically identical to the naturally occurring counterpart.

### SYNTHETIC GENOMICS

Focussing on the creation of the genome - the complete assemblage of an organisms genetic information.

# Building DNA Circuits.

*Construct gene circuits to solve problems*

---

## Aims

To learn how standard DNA components can be used to build circuits with applications in industry and biotechnology.

## Introduction

Biological engineering, sometimes referred to as synthetic biology, aims to take the logical design principles used in engineering and mathematics and apply it to biological systems. Through rational design, biological engineers can 'write' DNA to carry out a specific function. This process uses standard DNA and cell components - promoters, protein coding sequences, terminators and other biomolecules - that interact with each other to form a genetic circuit.

Genetic circuits have been used for a wide variety of applications in research and industry. Scientists

are able to program cells to give a desired output or process, such as the production of a complex molecule or a signal in response to environmental stimuli. Biological engineering can be used to find novel, more efficient and cheaper ways to carry out industrial processes which can help make products and technologies more accessible to vulnerable populations.

In this activity, students will be given cut-out DNA circuit parts to assemble into a working circuit. Students will then have the opportunity to design their own genetic circuit to carry out a function of their choice.



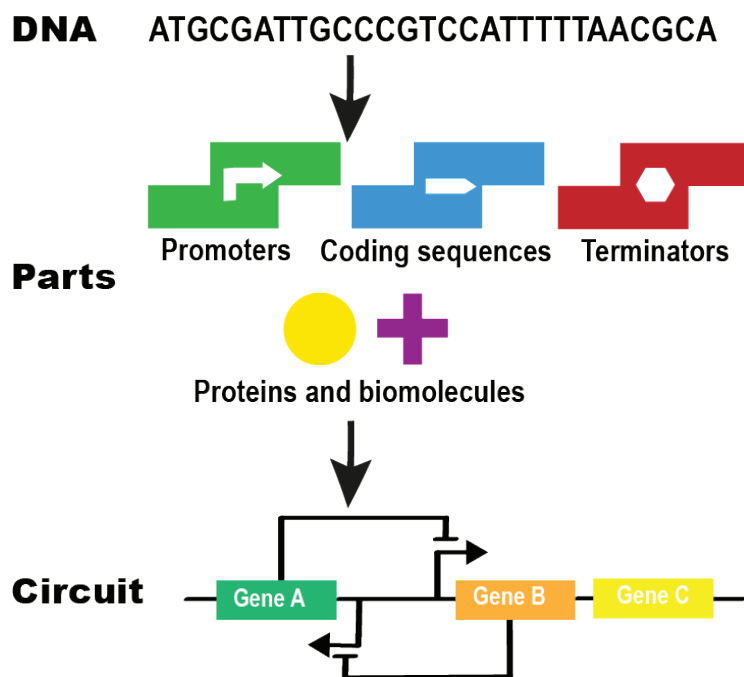

## Equipment and materials (per group)

### Equipment

Scissors

Glue

Pens/pencils

### Materials (All available in supplementary materials section of this booklet)

1 x Gene circuits information sheet

1 x Gene circuits poster

1 x Gene circuit (either The Biosensor, The Remediator or The Factory)

1 x 'Build Your Own' gene circuits pieces

## Methods

1. Get into a small group (~4 people per group is advisable).
2. Your group will need an information sheet, a copy of the poster to fill in and one of the three preset gene circuits (The Biosensor, The Remediator or The Factory).
3. In your group, using the information provided, assemble the gene circuit and glue it to the poster. Try and explain how your gene circuit works to neighbouring groups who have a different gene circuit.
4. In your group, use the additional 'Build Your Own' gene circuit pieces to design your own circuit that carries out a function of your choice. Glue it to the poster and present it to the other groups. Here are some points for you to consider:

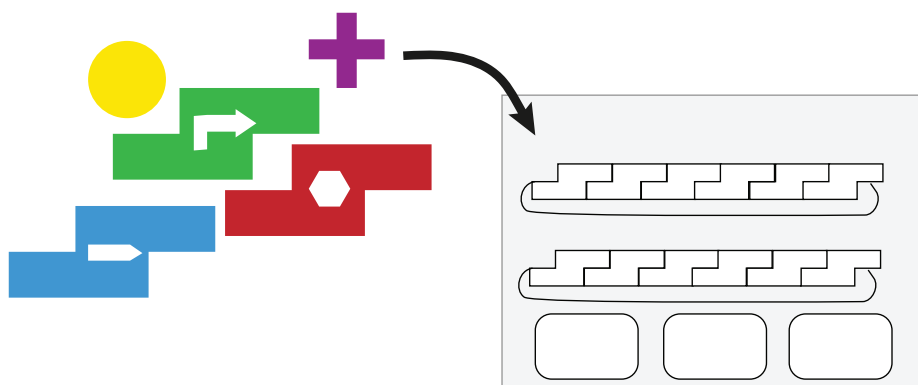

- What is the function of your gene circuit? Are you helping solve a current social/economic problem?
- How might you turn your gene circuit into a usable product? (e.g. would you express it in bacteria, put it into a handheld device, etc.)
- Who would benefit from the use of your gene circuit and who might not? Would you be impacting an existing industry or process?

### Preparation and timing

The activity as a whole takes roughly an hour. Solving the preset gene circuits takes roughly ~30 minutes, but this can be reduced to ~20 minutes if circuit pieces are pre-cut. Designing a circuit takes ~30 minutes.

### Troubleshooting

If students are struggling to come up with their own design, direct them towards the case studies, or suggest a real-world problem for them to solve as a starting point.

### Additional investigations

1. The technology produced through biological engineering can have huge social and economic impacts. Extend the 'design your own' circuit activity into a group project where students produce a researched report and presentation based on their circuit. This can be used to encourage thought on the ethical and social impacts, as well as laws and regulations that might stop their technology reaching the intended user.
2. Challenge students to find real world examples of The Biosensor, The Remediator and The Factory circuits.
3. Extend the 'design your own' circuit activity beyond the simple two gene circuit model.

## Further information

**igem.org** - *examples of synthetic biology projects designed by undergraduates as part of the International Genetically Engineered Machine Competition*

**futurism.media/what-is-gene-circuit-engineering** - *article explaining principles of gene circuit engineering, with links to more technical resources*

**Khalil AS & Collins JJ (2010) Synthetic Biology: applications come of age. Nature Reviews Genetics. 11 (5) 367-79** - *More advanced and technical article on synthetic biology and its potential applications*

**TEDx Talks (June 5, 2014) Synthetic biology - what should we be vibrating about?: Drew Endy at TEDxStanford ([https://www.youtube.com/watch?v=rf5tTe\\_i7aA](https://www.youtube.com/watch?v=rf5tTe_i7aA))** - *video of TEDx talk from Drew Endy explaining principles of biological engineering and how it might be used*

## Acknowledgements

**This activity was designed by Doctor Nicola Patron from the Earlham Institute.**

**Find out more about Doctor Patron's work here:**

**<https://www.earlham.ac.uk/nicola-patron>**

# Generating Electricity from Plants

*Build a plant microbial fuel cell (pMFC)*

## Aims

To demonstrate the principles of how plant microbial fuel cells (pMFC) can be used to generate electricity.

## Introduction

pMFCs are an emerging technology, which uses growing plants to produce power. As it does not depend upon fossil fuels, it is a renewable, green source of energy and can also utilise pre-existing plants in both urban and remote rural areas. The current power output of pMFCs is still insufficient to run a house or a car, but could be a valuable resource for remote populations to charge phones

In a pMFC, plants are grown in a container, with an anode (negatively charged electrode) and a cathode (positively charged electrode) in contact with the soil. During photosynthesis, plants produce organic matter that is then released into the soil as dead matter or root exudates. Soil bacteria living around plant roots can then break down this organic matter through oxidation reactions to produce protons and electrons. Bacteria donate these electrons to the

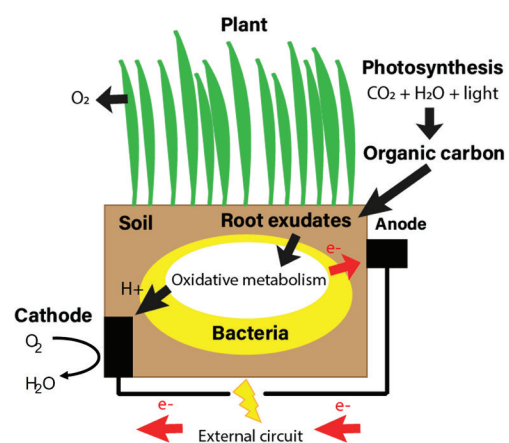

anode, which is connected to the cathode through an external circuit. The electrons move from the anode to the cathode via the wires of the external circuit, creating a current and ultimately electricity. Once at the cathode, oxygen accepts the electrons, along with protons, to produce water.

In this activity, students produce their own pMFC and learn how to measure the open circuit potential (OCP) and the closed circuit potential (CCP).

Find out more about the surprisingly long history of this technology in the supplementary information section.

## Equipment and materials

### Equipment

- 1 x Plastic container approximate min size of 12 x 8 x 5 cm (for example food Tupperware container, we recommend using a square or rectangular one).
- Stainless steel mesh (approximately 5 cm x 2 cm)
- 1 x stainless steel bolt and wing nut (non-corrosive)
- 2 x Soft gaskets (rubber or foam suggested)
- Carbon fibre sheet
- Platinum Carbon paper (maximum 2 x 2 cm)
- Black double ended crocodile clip (i.e. black wire with crocodile clip at both ends).
- Red double ended crocodile clip
- Resistor (1 k $\Omega$ )
- Duct tape (approximately 5cm x 5cm)
- Multimeter

A Generating Electricity from Plants Information Sheet can also be found in the Supplementary Materials section of this book. We recommend reading through all the instructions before starting to make your plant microbial fuel cell.

### Methods

**1. Make two holes in either side of your box (Figure 1).** A smaller upper hole for the anode (that your stainless steel bolt can pass through) and a bigger lower hole for the cathode (no greater than 1 cm x 1 cm).

Figure 1

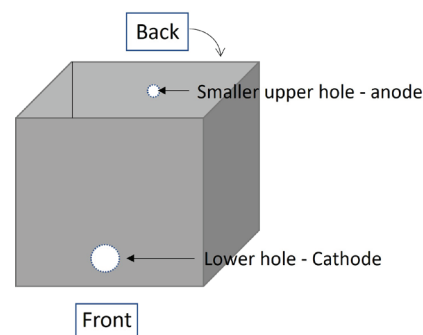

**2. Create the cathode (Figure 2).** Measure your piece of platinum carbon paper. Create a hole slightly smaller than your platinum carbon paper in a piece of duct tape. On the sticky side of the tape, place a piece of stainless-steel mesh so that it doesn't quite reach the hole in the tape but sticks out over the top of the tape.

In the final construction the black catalytic side of the platinum carbon paper should face outside the box and will be in contact with air. The grey side of the platinum carbon paper should face inside the box and be in contact with soil.

Apply the black face of the platinum carbon paper to the sticky side of the duct tape to completely cover the hole and overlap with the stainless steel mesh. Stick the duct tape, with the mesh and platinum carbon paper attached, to the outside of your box so that the carbon paper covers the lower (larger) hole. Ensure the tape is stuck firmly – it will ensure the hole is watertight and that the steel mesh is in electrical contact with the platinum carbon paper.

Figure 2

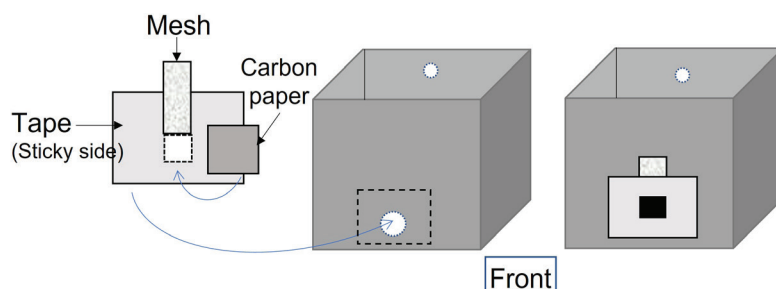

**3. Create the anode (Figure 3).** Separate some carbon fibres from the cloth, about 120 that are 20 cm in length. The number of fibres used and their length doesn't have to be precise. Place the fibres parallel to each other and tie a knot at each end to keep the strips together. Secure a bolt to the one end of the fibres by tying an additional knot and then fit the soft gasket to the bolt. Place the carbon fibres inside the box.

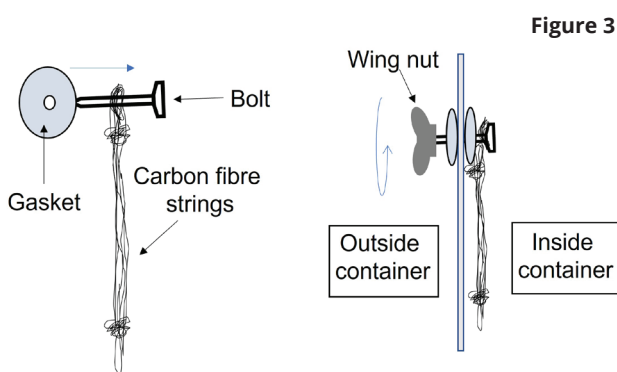

Secure the bolt into the upper hole of the box using the wing nut, with the soft gasket and carbon fibre inside the box, and the wing nut on the outside.

**4. Check the box is watertight (Figure 4).** Fill the container with water above the level of the cathode, to check it's watertight. Discard the water if it does not leak after 10 minutes.

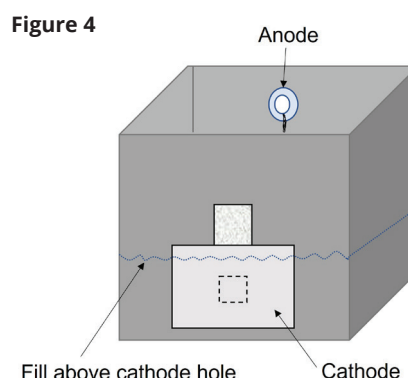

**5. Plant your seeds (Figure 5).** Half fill the box with soil and arrange the anode carbon fibre in the box on top of the soil to allow as much of the surface of the carbon fibre to touch the soil as possible. This will allow optimum contact of the microbes with the anode.

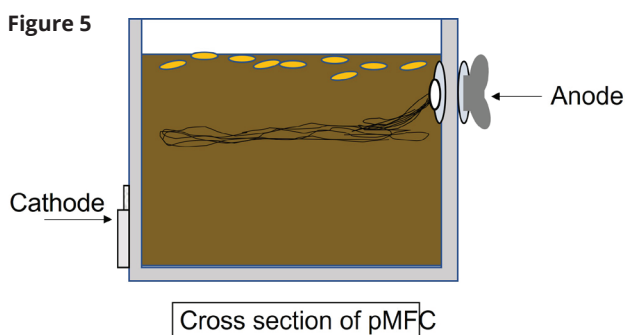

Fill the remainder of the box with soil to cover the carbon fibre. Water the soil and ensure that the lower levels of soil are completely submerged.

*Optional: place a plastic tube upright in the box before adding soil so you can view the water level.*

Sprinkle grass seeds onto the soil and add a little more soil on top. Wait a week or two for the grass seeds to grow. Ensure the soil is watered daily to ensure the cathode remains wet.

**7. Measure the open circuit potential (OCP) (Figure 6).** Attach the black wire to the steel mesh (cathode) using one crocodile clip. Secure the red wire to the wingnut (anode) with one crocodile clip. Connect the other ends of the wires to the multimeter.

Set the multimeter to 200 mV or 2000 mV. Read and record the value in mV, it should be negative. This gives the potential when a current is not flowing.

**8. Measure the closed-circuit potential (CCP) (Figure 7).** Leave the black and red wires attached to the stainless steel mesh (cathode) and wing nut (anode). Connect the other ends of the wires to opposite ends of the resistor.

Leaving the multimeter set to 200 mV or 2000 mV, place the corresponding-coloured probes onto the crocodile clips. Read and record the value in mV, it should be negative. This gives the potential when a current is flowing.

Figure 6

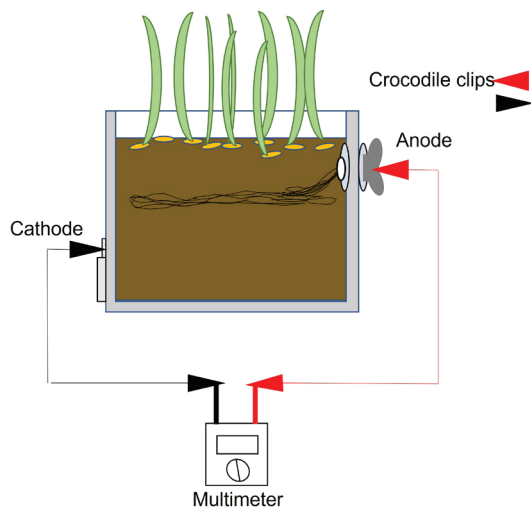
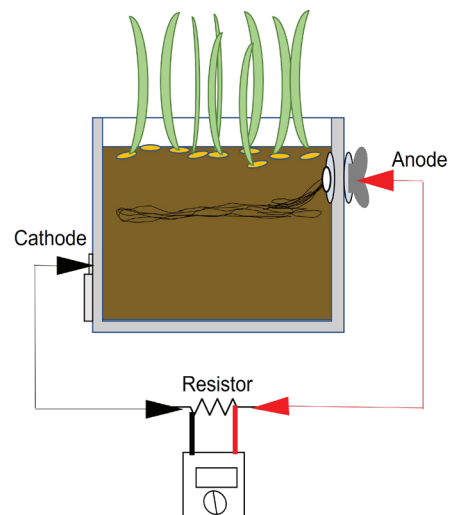

Figure 7



## Safety Guidelines

### ***Handling carbon platinum and carbon fibre***

Neither carbon platinum or carbon fibre are classified as hazardous, but care should be taken to avoid ingestion, prolonged contact with skin or contact with eyes as this may cause irritation.

### **Preparation and timing**

Building the pMFC takes ~ 1 hour if materials are prepared in advance (holes cut in boxes, carbon fibre bundles prepared, stainless steel mesh cut to size). Growth of the grass seeds takes roughly a week before measurements can be made.

### **Troubleshooting**

Water is vital for pMFC function. The lower area needs to be completely submerged, but the upper soil should be wet without being soaked. Generally, the roots should not be waterlogged as this can affect the bacterial community composition and activity.

## Additional investigations

1. The amount of current produced will vary with the type of plant and bacteria used in the pMFC. Try different species of plant or different soil types to see how it changes the circuit potential.
2. Photosynthesis is dependent on light, carbon dioxide and water, and can also be affected by nutrient availability. See how altering any of these factors changes circuit potential
3. See how much of an effect the presence of the plants have on the potential by looking at the potential of just the soil containing the microbes.
4. Explore the supplementary information to look inside some of the bacteria to see how

they conduct electricity.

## Sourcing Materials

**Carbon fibre sheet available at :** <https://www.easycomposites.co.uk/carbon-fibre-ve-neer-sheet>

**Platinum carbon paper available at :** <https://thesixtech.com/products/2-mg-cm-platinum-black-carbon-paper?variant=37141492859042>

**Stainless steel mesh available at :** <https://www.inoxia.co.uk/products/mesh/sheets/60-mesh>

## Further information

**[auto.howstuffworks.com/fuel-efficiency/alternative-fuels/plant-microbial-fuel-cell.htm](http://auto.howstuffworks.com/fuel-efficiency/alternative-fuels/plant-microbial-fuel-cell.htm)** - *article explaining the context, principles and potential uses of pMFCs*

**plant-e.com** - *company based in the Netherlands that produce plant microbial fuel cells for industry and urban areas*

**[bioc.cam.ac.uk/howe/members/paolo-bombello-postdoctoral-researcher-1](http://bioc.cam.ac.uk/howe/members/paolo-bombello-postdoctoral-researcher-1)** - *further information on the research carried out by Paolo Bombelli at the University of Cambridge on pMFCs and links to more in depth papers*

**McCormick et al. (2015) Biophotovoltaics: oxygenic photosynthetic organisms in the world of bioelectrochemical systems. Energy and Environmental Science. 8; 1092-1109** - *review on using photosynthetic organisms in fuel cells*

## Acknowledgements

This activity was designed by Dr Paolo Bombelli in the Department of Biochemistry from the University of Cambridge.

Find out more about Dr Paolo Bombelli's work here:

**<https://www.bioc.cam.ac.uk/howe/members/paolo-bombello-postdoctoral-researcher-1>**



# What Can Viruses Do For You?

*Build virus structures for different applications*

## Aims

Show how virus structures are being harnessed in research and industry for various applications, and discover what aspects of virus structures make them suitable for these applications.

## Introduction

Viruses are small infectious particles, made up of nucleic acids (DNA or RNA) protected by a protein coat (capsid), and sometimes surrounded by a lipid envelope. Capable of infecting animals, plants and bacteria, viruses are responsible for some highly debilitating diseases, such as Ebola and Covid-19, as well as less severe illnesses such as the common cold and flu. The disease symptoms that viruses cause is a result of their life cycle. Viruses cannot reproduce by themselves and have to commandeer host cell environments and machinery to replicate and assemble more viral particles. Once enough particles have been produced inside the infected cell, the cell bursts releasing the viruses for another round of infection.

Viruses are exceptionally small, generally being in the nanometer range (one-billionth of a meter). For a long time, this impeded our understanding of the capsid structure and how they form. We now know that

capsids are built from self-assembling, repeating units called capsomers, that generate a huge range of capsid shapes and sizes. Researchers and industry are now beginning to appreciate how the rich variety of structures seen in the viral world might be utilised for various processes, especially within the field of biomedicine.

In this activity, students are given a 'design brief' based around using virus structures to build nanowires, targeted drug delivery vehicles or vaccines. Students can work alone or in groups to build a model from various materials to demonstrate the 3D structure of their virus-based designs. Students should be given a variety of craft materials (pipe cleaners, cotton balls, etc.) that can represent sugar or protein modifications to the virus structure surface, but generally are encouraged to be creative and use their imagination when building the models.

## Equipment and materials

### Materials

- Cardboard tube (brief 1)
- Perforated plastic ball (brief 2)
- Polystyrene/plasticine ball (brief 3)
- Glue
- Pipe cleaners, cotton balls, felt tips, plasticine, other craft materials, etc.

### Brief 1: Tobacco mosaic virus (TMV) and nanowires

You're studying the rod-shaped tobacco mosaic virus (TMV- 300 nm long, 18 nm diameter) and you notice it's shape and size is quite similar to a nanowire. You know that genetic and chemical modification techniques allow you to attach useful proteins or molecules on the virus protein surface. This could be useful for modifying the virus for different nanowire functions, such as making it able to bind other molecules or materials. You decide to come up with a virus-based nanowire design:

**Nanowires** are wires that are only nanometers thick but can be millions of times longer. This gives them useful properties for applications in electronics and optics, such as fast electron conductance and high surface area to volume ratio. They have also been utilised as sensors through exploiting the electrical signals that occur when molecules bind to receptors, and to bring together materials that do not mix. Nanowires have been built from a range of different metals and elements in the past, such as gold and magnesium oxide.

- What functions does your nanowire carry out?
- What modifications have you added to the virus to help it carry out its function?
- Are there any considerations for the manufacturing process (e.g. stability, safety, etc.)?
- What possible advantages and disadvantages can you think of for producing a nanowire using a virus structure?

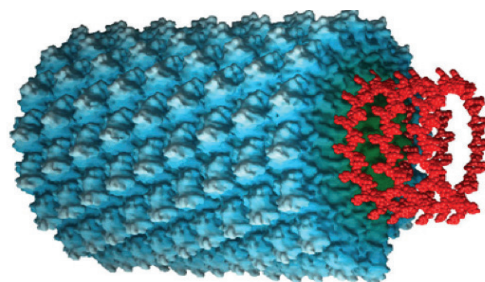

### Brief 2: MS2 bacteriophage and targeted drug delivery

**Targeted drug delivery** is a technique that directs an administered drug to a specific cell type or tissue within the body. The drug is put inside a molecular 'cage' or 'vehicle' that will recognise and bind specifically to the cells of interest. This helps ensure a build-up of medicine around diseased tissues and reduces potential side effects medications might have on healthy tissues. The vehicles used need to be stable *in vivo* and *in vitro* and be non-toxic. Liposomes enriched with polyethylene glycol (PEG) are commonly used for drug delivery.

You are studying the structure of the MS2 bacteriophage, an RNA virus that infects *Escherichia coli*. It has an icosahedral structure (many faces that appear like equilateral triangles arranged in a symmetrical fashion around the nucleic acid genome). The icosahedral structure provides a large surface area for displaying various proteins and molecular modifications that could be useful for targeting the virus to different tissues, while also protecting anything inside the shell. You think this makes it an ideal candidate for use in

targeted drug delivery:

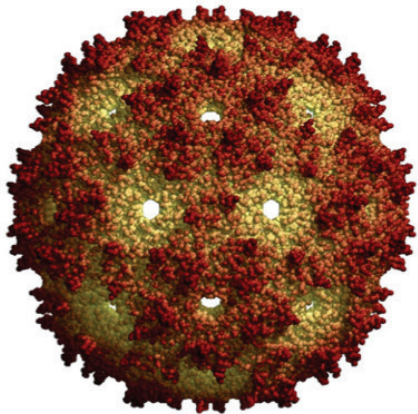

- What disease are you interested in treating? (this can be real or made up)
- How will the drug be targeted to specific tissues?
- How will you ensure that the drug is not released before it gets to the tissue of interest and then subsequently released when it is needed?
- What safety measures will you have to take into consideration in transforming an infectious virus into a delivery vesicle?

### Brief 3: Virus like particles (VLPs) as vaccines

You are working on producing a vaccine for a new viral disease that is rapidly spreading across Europe. The virus mutates extremely quickly, so has multiple strains with various antigens. Traditional vaccine production methods cannot keep up and also require handling the dangerous virus. You hear about the production of virus-like particles (VLPs) in plants, which involves producing the virus capsid and its antigens inside the plant, purifying them and using them for vaccines. You can also add protein and sugar modifications to the virus surface to help purification and stability. You think it sounds like a promising way to tackle the spread of the disease:

- What virus structure will you be working with - icosahedral, helical, etc?
- Consider what molecules might be an antigen on the virus surface. How will these be displayed - on the protein structure or lipid envelope? How many different types?
- What modifications will you add to make purification from the plant expression system easier?
- What other modifications might you have to consider making to aid manufacturing, storage and administration?

**Vaccines** are biological preparations that provide immunity against specific diseases through stimulating antibody production against antigens present on pathogens. Traditionally, vaccines against viral diseases contained inactivated or weakened forms of the virus, but this can pose potential safety problems in production and administration and also means vaccine production for fast-mutating viruses can be slow. **Virus-like particles (VLPs)** are self-assembled virus proteins that do not carry the viral nucleic acid genome, making them non-infectious. VLPs can be produced rapidly and used to display multiple copies of antigens, meaning immunity against several different strains can be delivered at once. VLPs are an emerging technology for safer, cheaper and more rapid vaccine production.

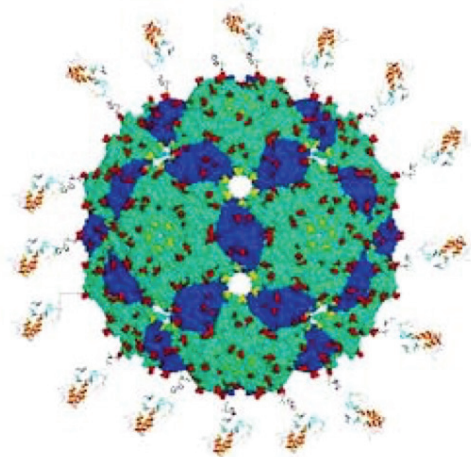

### Preparation and timing

The practical can be run in 1 hour. Reading the practical and researching any additional background information takes roughly ~20 minutes, with ~20 minutes building the structure and ~20 minutes on presenting and discussing structures.

## Troubleshooting

If students are struggling to come up with ideas, guide them towards case studies or assist with suggestions to give them a starting point. A What Can Viruses Do For You? Information Sheet is also available in the Supplementary Materials section of this booklet.

## Additional investigations

1. Viruses are currently being used in research and technology for a wide range of applications. Ask students to find real life examples of each of the briefs described in the activity.
2. Set this activity as an extended group project and ask students to create a presentation with further detail about the virus structures they are working on, and the techniques they might have to use.
3. If you have access to a 3D printer, investigate some of the virus models you can print on [yeggi.com](http://yeggi.com)

## Further information

**Roger Castells (June 22, 2018) Production of Virus-like particles in plants (<https://www.youtube.com/watch?v=hEXkEuoA3UE&feature=youtu.be>)** - *Explanation about the research behind producing VLPs in plants*

**Freethink (February 19, 2018) Could growing vaccines in plants save lives? (<https://www.youtube.com/watch?v=kkAb2WB17I4>)** - *Further detail about producing VLPs in plants*

**Shirbaghaee & Bolhassani (2015) Biopolymers. Different applications of virus-like particles in biology and medicine: vaccination and delivery systems. 105 (3); 113-127** - *Review on the applications of VLPs in medicine*

**[news.mit.edu/2013/explained-nanowires-and-nanotubes-0411](https://news.mit.edu/2013/explained-nanowires-and-nanotubes-0411)** - *Articles explaining the principles of nanowires and nanotubes*

**[news.mit.edu/2013/better-batteries-through-biology-1113](https://news.mit.edu/2013/better-batteries-through-biology-1113)** - *Article describing the work done to build virus-assisted nanowires*

## Acknowledgements

This activity was designed by Roger Castells Graells from the John Innes Centre

Find out more about Roger Castells Graells work here:

<https://www.jic.ac.uk/people/roger-castells-graells/>

# Natural Product Synthesis.

*Match up the organisms and the natural products*

---

## Aims

To understand what synthetic biology is and how it can be used for natural product synthesis.

## Introduction

Synthetic biology aims to apply engineering principles to biology in order to (re)design and produce compounds and systems which do not naturally occur. The aim is for us to be able to reprogram biological systems for improved and sustainable bioproduction. Although this field has been heavily geared towards microbes, there is now a great effort into engineering plant systems for sustainable bioproduction.

Synthetic biologists are working to develop standardised biological parts that can be rapidly synthesised and used to build new biological systems. This has already begun in the form of BioBricks. BioBricks are DNA parts which can be used as building blocks to create synthetic biological circuits. They

conform to a restriction enzyme assembly standard for ease of use. Another major goal is natural product synthesis. This is when organisms are engineered to perform complex, multistep pathways and using specific enzymes, produce a desired natural product. These organisms are referred to as 'biofactories'.

In this activity students have the opportunity to explore an example of how synthetic biology has enabled yeast to work as a biofactory for the production of opioids. Students then have the opportunity to explore other examples of how synthetic biologists have used organisms for natural product synthesis.

## Case Study - Opioid synthesis in yeast.

Opioids are a class of medicines used for treating severe pain, examples include morphine and codeine. Opioids are extremely useful tools in medicine, therefore demand for them is high. Currently, poppies (*Papaver somniferum*) are farmed for the production of opioids, however synthetic biologists have engineered yeast (*Saccharomyces cerevisia*) to produce precursors to opioids.

Yeast was chosen for the task for numerous reasons including that it has well developed genetic resources and has only 16 chromosomes making the alteration of its genetics easier.

In order to reconstruct the opioid pathway within yeast, scientists inserted 23 genes into the yeast genome from 6 different species. Each gene contained the genetic information to encode the production of a specific enzyme. Each enzyme is crucial to a step in the pathway. The pathway itself is

extremely complex and contains many intermediates, therefore it was broken down into steps to simplify the problem. For each step a module of genes was created. Some of the genes, including some genes the yeast already possessed, were modified before use to ensure the pathway worked as efficiently as possible within the yeast, which is a much more acidic environment than poppy.

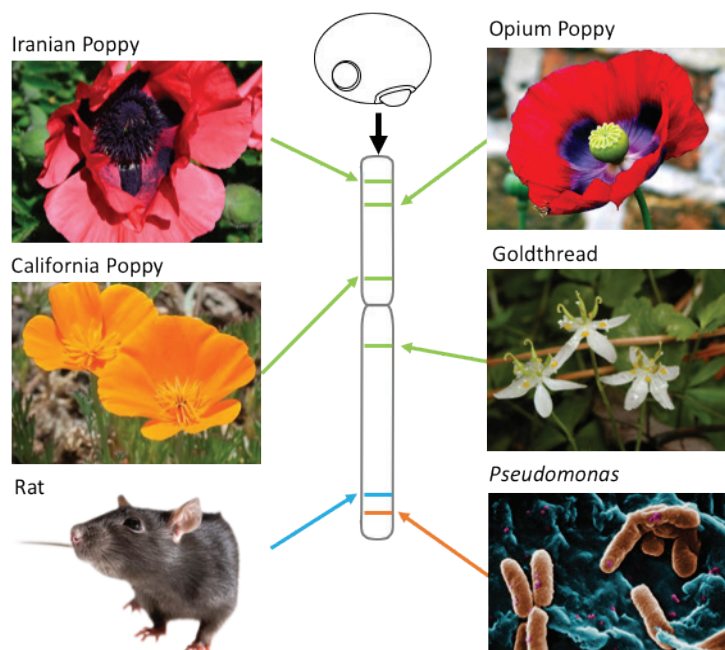

There are many advantages to using yeast over poppies to produce opioids. Poppies are annuals, however yeast can produce opioids in just 3-5 days, a huge reduction in time. In addition to the reduction in time, there is also a great reduction in space, whilst poppies require a huge land area for growth, the bioreactors in which yeast can be grown are significantly smaller. Furthermore growth in a fermenter means that the yeast can be grown in a controlled environment free from pests and disease and under constant conditions, without the threat of poor weather which poppy fields are exposed to.

Whilst there are obvious advantages to this, there are also many ethical considerations



when we think about synthetic biology. Whilst this technology has the potential to completely transform the realms of possibility, it is important to consider that this technology also has the potential to be used for harm and not good.

There are fears this technology could be used for bioweaponry and also that the modification of existing and new synthetic organisms challenges our relationship with the natural world.

## Equipment and Materials

### Equipment

- Pens

### Materials

- 1x Engineering Natural Products Sheet

### Methods

1. Once you have read through and discussed the case study, you should use the engineering natural products sheet to explore more examples of natural product synthesis.
2. The clues should allow you to match each compound with an organism that has been engineered to produce it.

### Preparation and Timing

This lesson can be conducted over ~45 mins. Reading through the case study and discussing it should take ~ 30 minutes. Match up game with organisms and natural products should take ~ 15 minutes to complete but can be extended by discussion of answers, why the students matched them the way they did.

### Troubleshooting

If students are struggling to match the natural product to the organism, suggest they discuss it in groups to think of what properties would be useful in an organism used to produce the product.

### Additional investigations

There are many compounds which could potentially be produced using this technology, challenge students to think of more compounds which could be produced in this way.

Extend your "Natural Product Synthesis" by getting students to research one of the examples from the 'Match up game' and create their own case study.

There are many social and ethical implications of natural product synthesis, ask students to discuss these and encourage debate on this topic.

## Further Information

techNyouvids (July 22, 2011) What is Synthetic Biology? ([https://www.youtube.com/watch?v=H\\_CLySMFP38](https://www.youtube.com/watch?v=H_CLySMFP38)) – Video explaining Synthetic Biology.

<https://www.bio.org/articles/synthetic-biology-explained> - Article explaining the basic aims and principles of synthetic biology.

Galanie et al. (2015) Science. Complete biosynthesis of opioids in yeast. – Paper explaining synthesis of opioids in yeast.

Bruce Goldberg (April 2, 2018) <https://med.stanford.edu/news/all-news/2018/04/researchers-engineer-yeast-to-manufacture-complex-medicine.html> - Article describing opioid production in yeast.

Lorenzo Caputi <https://www.jic.ac.uk/news-and-events/blog-copy/2018/03/vinblastine-and-vincristine-life-saving-drugs-peri/> - Article with more information about vinblastine in Madagascan Periwinkle.

## Acknowledgements.

**This activity was designed by Shannon Woodhouse from the John Innes Centre**

**Find out more about Shannons work here:**

**<https://www.jic.ac.uk/people/shannon-woodhouse/>**



# Engineering Natural Products

Here are more examples of natural products and host organisms synthetic biologists have engineered to produce them.

Can you match the natural product to the organism engineered to produce it? The organism may already naturally produce the product but synthetic biologists may have engineered it to produce higher yields.

The first one is the example we have already seen, opioids produced by yeast.

## Thebaine

Opioid precursor.  
Pain relief.  
Produced naturally in poppy.

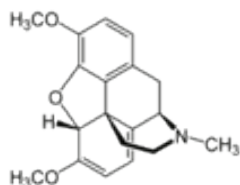

## *Saccharomyces cerevisiae*

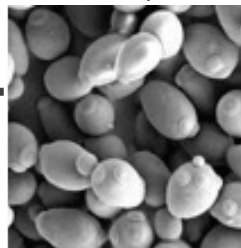

Yeast  
Full genome sequence  
Small  
Short lifecycle

## Penicillin

Antibiotic.  
Produced naturally by Penicillium mould.  
Last steps in synthesis require peroxisomes.

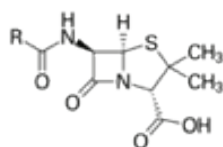

## *Catharanthus roseus*



Plant  
Natural producer of vincristine and related compounds

## Artemesinic Acid

Artemisinin precursor.  
Antimalarial drug.  
Produced naturally in Sweet Wormwood.  
Expensive, in short supply.

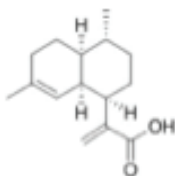

## *Hansenula polymorpha*

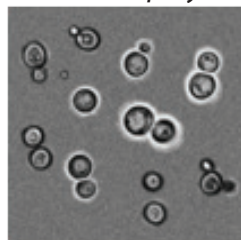

Yeast  
Full genome sequence  
Short lifecycle  
Large peroxisomes

## Cobalamin

Vitamin B12.  
Water soluble.  
Essential for the nervous system.

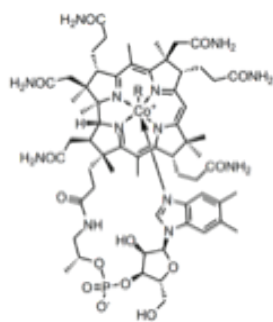

## *Escherichia coli*

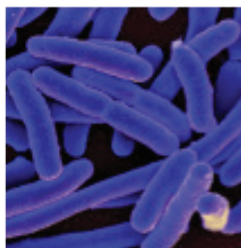

Bacteria  
Rapid Lifecycle  
Full genome sequence  
Cheap to grow.

## Vinblastine

Anticancer drug.  
Produced naturally by Madagascan Periwinkle.  
Low yields.

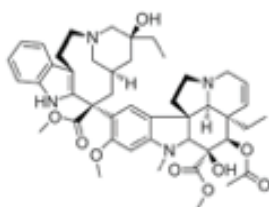

## *Chlamydomonas reinhardtii*

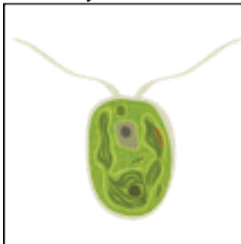

Algae  
Short lifecycle  
Full genome sequence  
Produces vitamin B12

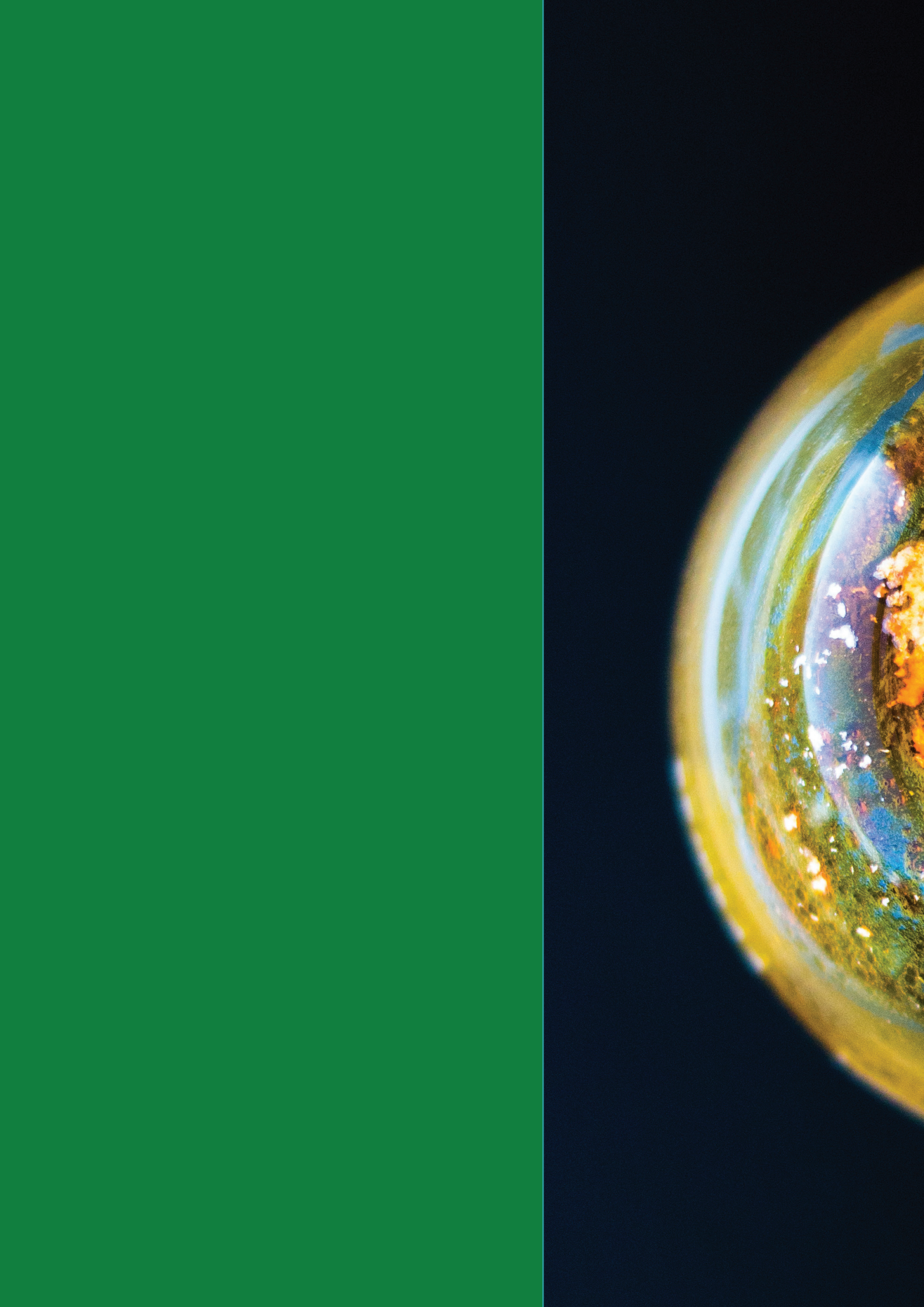

# Supplementary materials



In this section you will find all the additional materials needed for each of the activities.

All of the following need to be printed single sided on A4, unless stated otherwise.

---

## **Including:**

### **Building DNA Circuits** (Print all single sided)

- Information Sheet
- Gene circuits poster (print on A3 where possible, if not, use as template)
- The Biosensor, The Remediator and The Factory gene circuits
- Build your own gene circuit pieces

### **Generating Electricity From Plants**

- Supplementary information sheet

### **What can viruses do for you?**

- Supplementary information sheet.

### **Natural Product Synthesis**

- Engineering natural products answer sheet



# Gene circuits info sheet



## The Biosensor

Living cells are constantly responding to changes in the environment such as food, temperature and danger from pests and pathogens. They do this by changing which genes they express and the levels of gene expression.

By repurposing different DNA sequences with specific functions, we can build a new genetic circuit that programs the cell to turn bright yellow when it detects the presence of, for example, a drug that we wish to monitor the presence of in the waste-water escaping from a factory that produces pharmaceuticals.

Find and arrange the DNA parts that form a genetic circuit that programs cells to produce the yellow fluorescent protein  when they are mixed with a sample of water contaminated with the drug .

## The Factory

Many pharmaceutical compounds like drugs and vaccines are natural products found in, for example, certain species of bacteria, plants and fungi.

Some of these compounds are only present in small quantities and are therefore very expensive. Because these products are made by organisms we can find the DNA that codes for them and provide this to another organism such as yeast as a template for manufacturing large quantities.

Find and arrange the DNA parts that form a circuit that program cells to produce the viral surface protein  that can be used as a vaccine. *You need to be careful to make sure that the cell culture only produce the viral surface protein when it has stopped feeding and growing otherwise the cells will make protein instead of growing and dividing into a large culture of cells and the yield will be very low.*

## The Remediator

Some organisms, especially plants, that cannot run away from danger, detect and respond to threats in the environment by producing a product to neutralize the danger. Examples are the production of molecules that taste bitter in response to damage by a herbivore or producing an enzyme that breaks downs or inactivates an toxin or heavy metal in the soil.

Find and arrange the DNA parts that form a circuit that can be used to re-program cells to detect and break down the toxic molecule .

## What else could you program a cell to do?

Using the spare DNA parts, design your own two-gene circuit that can be used to program a cell to do or produce something useful.

- Think about what signals you want the genetic circuit to respond to and what the outputs of that circuit might be.
- Label all the parts and products of your circuits to explain how it functions.
- Think about what kind of cell you might want to put your circuit into – bacteria, plant, yeast etc. ? Why did you make this choice?

Biological engineers work to a code of practice to ensure that they do not do anything that is unethical or risky. This is sometimes called Responsible Research and Innovation (RRI). The first step of RRI is to define what the benefits (social, economic etc.) are of the project.

The second step is to identify any issues or risks that might arise. These could include everything from risk of contaminating the environment or exposing the population to an allergen to making something that is so new and innovative that people are afraid of it or that government agencies do not have a process to check if it is safe.

- What issues or risks do you think that your engineered organism raises?
- Who might you need to consult with to learn more about these issues to make sure that they do not cause a problem?

**!** What do the 4 letters of DNA at the start and end of every part mean? These four bases define which type of DNA part it is and allows for the simultaneous assembly of multiple DNA parts into larger circuits. Notice how the bases on a given DNA part can only base-pair correctly (A&T and C&G) with certain parts. This ensures that DNA parts can only join together (ligate) if they will make a proper genetic unit (promoter-coding sequence-terminator). In synthetic biology, this is known as an 'assembly standard'.

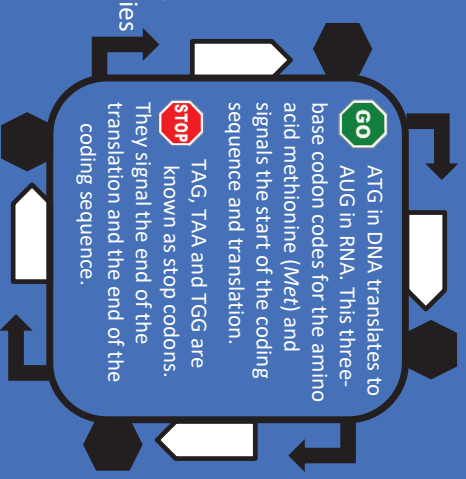

# Gene circuits poster

## ENGINEERING BIOLOGY WITH DNA



BUILD A GENE CIRCUIT WITH DNA PARTS



DESIGN YOUR OWN GENE CIRCUIT

WHAT IS THE FUNCTION OF YOUR GENE CIRCUIT?

WHAT ARE THE BENEFITS OF YOUR GENE CIRCUIT?

WHAT ISSUES CAN YOU THINK OF IF INTRODUCING THIS INTO SOCIETY?

Biosensor circuit



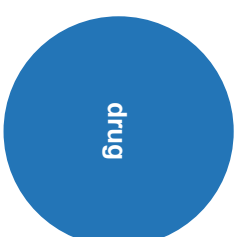

**CCTC**  
**Promoter** – This promoter is 'constitutive'. This means that it activates gene expression in all cells, at all stages of development.



Biosensor circuit



**ACTG**

**Promoter** – This promoter only drives gene expression when the activated **TRANSCRIPTION FACTOR** complex binds to its DNA sequence. This complex is formed when the protein  binds the drug 



Transcription factor (inactive)



Yellow Fluorescent Protein (YFP)

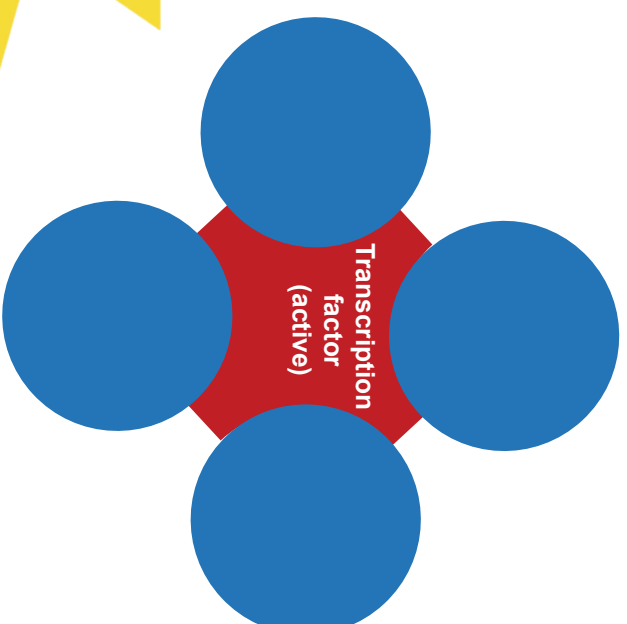



Biosensor circuit



tag  
tgg  
tga  
**GCTT**

**TTAC**



This Coding Sequence (or CDS) codes for a protein  that can function as a TRANSCRIPTION FACTOR to activate promoters with a particular recognition sequence, but only when it is bound to a specific substrate molecule 

Biosensor circuit



tag  
tgg  
tga  
**GCTT**

**TTAC**



This Coding Sequence (or CDS) codes for a protein  that emits fluorescent yellow in UV light.

Biosensor circuit



**CGCT**

**CGAA**

'Terminator' stops gene expression (transcription) by causing the RNA polymerase to disengage from the DNA strand

Biosensor circuit

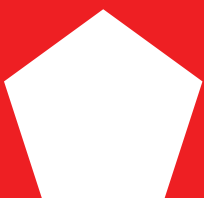

**TGAC**

**CGAA**

'Terminator' stops gene expression (transcription) by causing the RNA polymerase to disengage from the DNA strand

Factory circuit:



**GO**  
**AATG**

**CCTC**

**Promoter** – This promoter is ‘constitutive’. This means that it activates gene expression in all cells, at all stages of development.







Factory circuit:



**GO**  
**AATG**

**ACTG**

**Promoter** – This promoter is repressed by the presence of the transcription factor  which is formed when the protein  is activated by the nutrient phosphate  in the growth media. When nutrients are running low, levels of  drop and this promoter is activated.

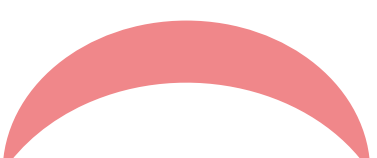
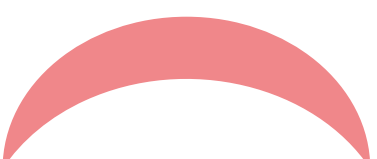

Transcription factor (active)



viral surface protein



viral surface protein





Factory circuit



tag  
tgg  
tga

**GCTT**

**TTAC**



This Coding Sequence (or CDS) codes for a protein ( ) that can function as a repressor of transcription following activation by phosphate (●)

Factory circuit



tag  
tgg  
tga

**GCTT**

**TTAC**



This Coding Sequence (or CDS) codes for the surface protein ( + ) of a virus. It can be used to vaccinate animals against that virus.

Factory circuit

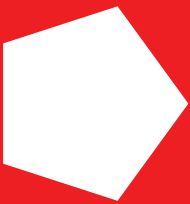

**CGCT**

**CGAA**

'Terminator' stops gene expression (transcription) by causing the RNA polymerase to disengage from the DNA strand

**TGAC**

Factory circuit

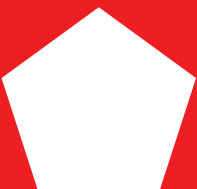

**CGAA**

'Terminator' stops gene expression (transcription) by causing the RNA polymerase to disengage from the DNA strand

Remediator circuit



tag  
tgg  
tga  
**GCTT**

**TTAC**  
This Coding Sequence (or CDS) codes for a protein that functions as a TRANSCRIPTION FACTOR.



Remediator circuit



tag  
tgg  
tga  
**GCTT**

**TTAC**  
This Coding Sequence (or CDS) codes for an enzyme that is able to break down the toxic molecule



Remediator circuit



**CGCT**

**CGAA**  
'Terminator' stops gene expression (transcription) by causing the RNA polymerase to disengage from the DNA strand

**TGAC**

Remediator circuit



**CGAA** 'Terminator' stops gene expression (transcription) by causing the RNA polymerase to disengage from the DNA strand

Remediator circuit



AATG



**CCTC**

**Promoter** – This promoter only activates gene expression when it receives a signal from the cell surface that the cell has encountered a particular toxic molecule

Transcription factor

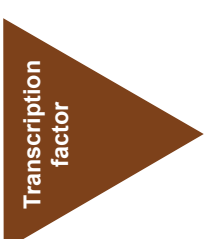

Transcription factor

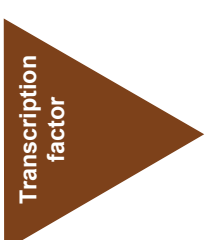

Transcription factor

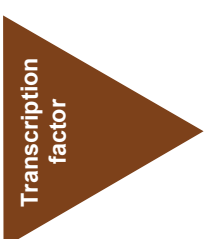

Transcription factor



Remediator circuit



AATG



**ACTG**

**Promoter** – This promoter is activated when the **TRANSCRIPTION FACTOR** binds to a specific sequences of its DNA. The more of these sequences are bound the more product is made

Toxic!



Toxic!



Build your own



Promoter –



Build your own

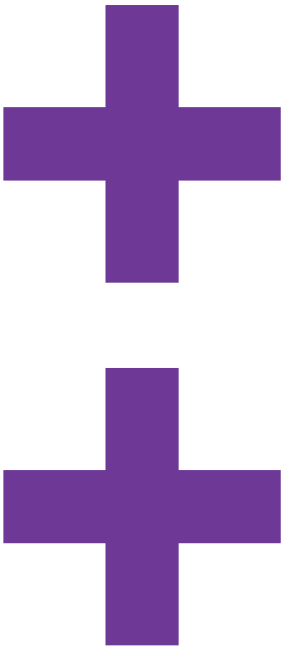
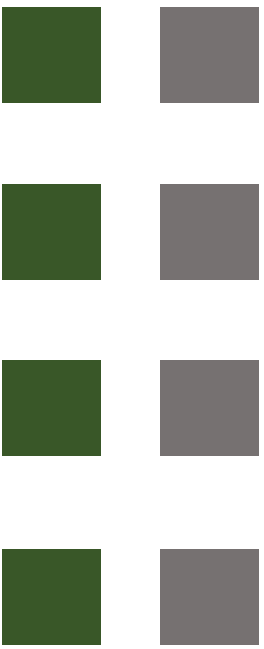

Promoter –

Build your own



**CGAA**  
**'Terminator'** stops gene expression (transcription) by causing the RNA polymerase to disengage from the DNA strand

Build your own



**CGAA**  
**'Terminator'** stops gene expression (transcription) by causing the RNA polymerase to disengage from the DNA strand

Build your own

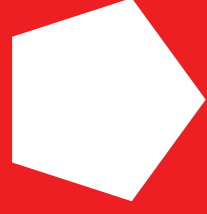

**CGAA**  
**'Terminator'** stops gene expression (transcription) by causing the RNA polymerase to disengage from the DNA strand

Build your own



**CGAA** **'Terminator'** stops gene expression (transcription) by causing the RNA polymerase to disengage from the DNA strand

Build your own



tag  
tgg  
tga

**GCTT**

**TTAC**



Coding Sequence –

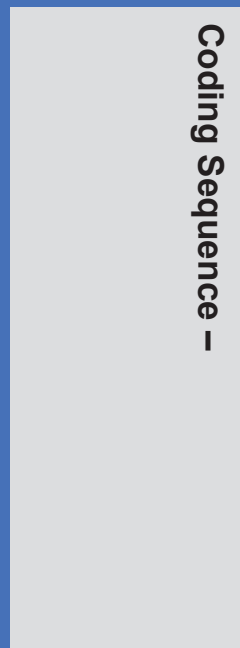

Build your own



tag  
tgg  
tga

**GCTT**

**TTAC**



Coding Sequence –



Build your own



tag  
tgg  
tga

**GCTT**

**TTAC**



Coding Sequence –



Build your own



tag  
tgg  
tga

**GCTT**

Coding Sequence –

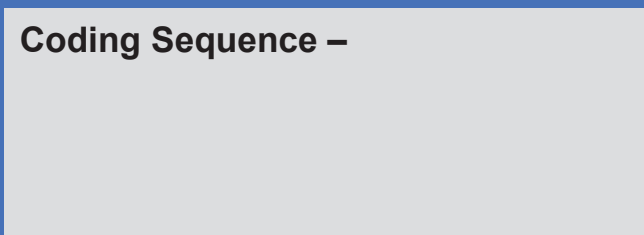

**TTAC**



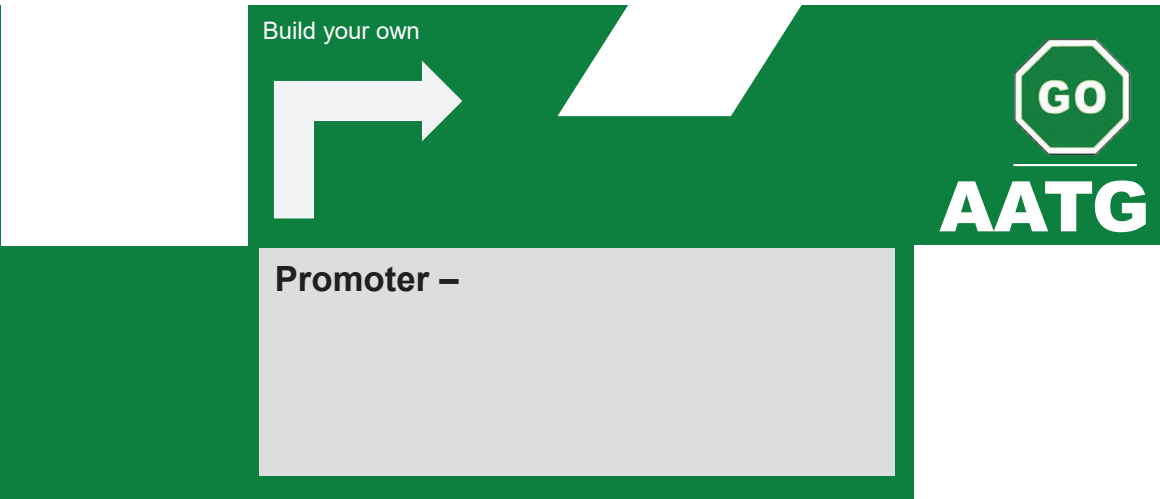
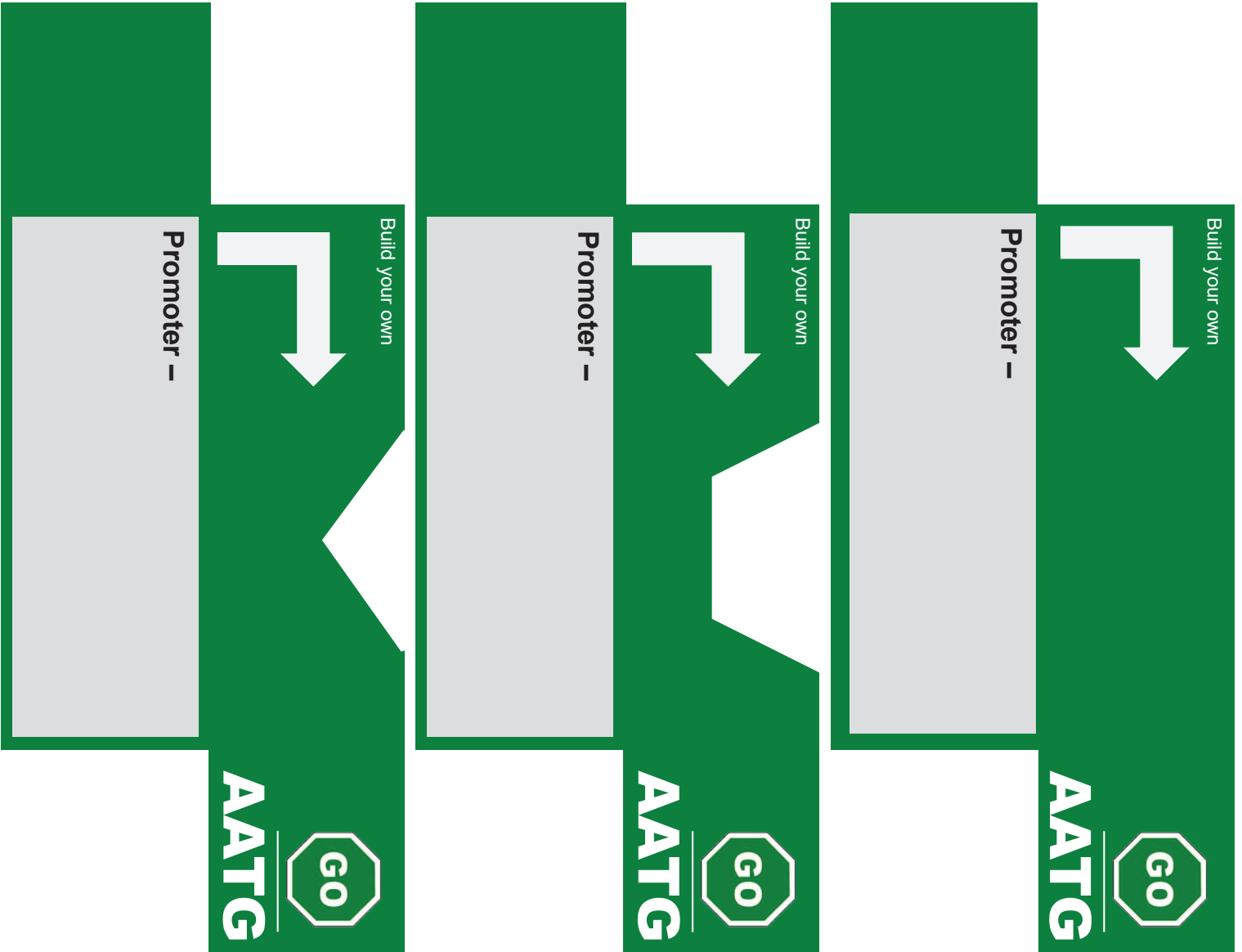

# Generating Electricity From Plants

## Supplementary Information Sheet

### The first biocatalyst - Potter's microbial fuel cell

In 1789, Luigi Galvani, a physician and professor at the University of Bologna, was running some experiments using frog legs. He discovered that if you struck the muscle of the frog leg with an electrical spark it caused the muscles to contract and the leg to move, as if it were still alive. At the time, Galvani claimed this was the result of a new form of electricity called "animal electricity" found in living tissues. Although later experiments disproved some of Galvani's interpretations and ideas of animal electricity, subsequent research expanding on his investigations demonstrated that biochemical processes and reactions in cells are associated with a change in electrical potential.

Inspired by Galvani's work, and based on his own observations of how bacteria degraded organic materials, in 1911 an English botanist named Michael C. Potter built the first microbial fuel cell (MFC). By demonstrating that current could flow between two electrodes submerged in a bacterial culture, Potter showed that the chemical reactions that occur as bacteria break down sugars and organic compounds could be harnessed at the anode to generate electricity. More importantly, the bacteria at the anode acted as self-replicating biocatalysts, and the process produced electricity without any harmful side-products or pollutants.

Potter's original observations and demonstrations in 1911, suggested microbial fuel cells could provide only very small power outputs. However, since then bacteria capable of producing much greater power have been discovered. These bacteria include *Geobacter metallireducens* which was isolated from the Potomac River in Washington D.C. (1987) and *Shewanella oneidensis* isolated from Lake Oneida, New York (1988).

### Bacteria as electron donors

Over the last 20 years bacteria capable of generating high powers in MFCs and plant MFCs have been studied by many researchers world-wide. Important questions to answer were how and why these bacteria produce electricity. All bacteria gain their energy from oxidation of fuel molecules such as small carbon-based molecules and sugars (like those exuded by plant roots into the surrounding soil). Proteins called enzymes inside the bacteria catalyse the breakdown

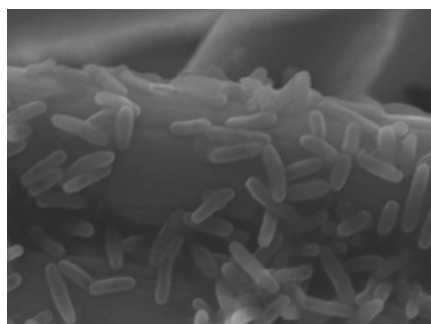

of these molecules, which produce electrons as a by-product. We now know that bacteria producing high power in MFCs are special because they are readily able to pass their excess electrons across the cell walls and to anodes (Figures 1 & 2).

Figure 1. Scanning Electron Micrograph (SEM) of *Shewanella* on an electrode. Image credit: Dr Tom Clarke, University of East Anglia.



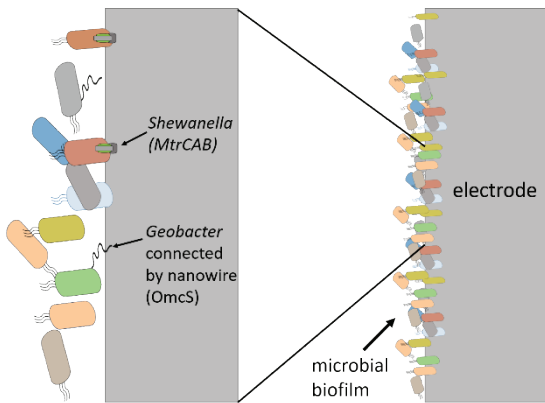

Figure 2. Bacteria cluster together on electrode surfaces forming biofilms. The bacteria oxidise fuel molecules to gain energy and produce spare electrons as a by product that can be passed to the anode of MFCs and pMFCs. Bacteria like *Shewanella* make direct electrical contact with the electrode while bacteria like *Geobacter* form extracellular nanowires enabling them to electrically connect to electrodes over longer distances.

Species of *Shewanella* and *Geobacter* have special proteins that enable them to conduct electrons across their cell walls, and from the surface of bacteria to the electrodes. Recent research has revealed the structures of some of these proteins, Figures 3 & 4. An important feature is that the proteins contain iron atoms, positioned like beads on a string, to form a chain extending across the protein. Iron, being a metal, conducts electrons across the proteins. The outer membrane of *Shewanella* is spanned by the electrically conductive MTR complex (Figure 3). This complex conducts electrons between the inside and outside of bacteria. *Geobacter* produce much longer iron-containing biomolecular wires (Figure 4). The biomolecular wires are assembled from many copies of a single protein. They can extend over distances 10-times longer than the bacterium they are attached to. They allow bacteria to wire up to electrodes that are some distance away. They also allow bacteria to wire-up to one another. In this way bacteria even further from the electrode can become part of the electrical circuit.

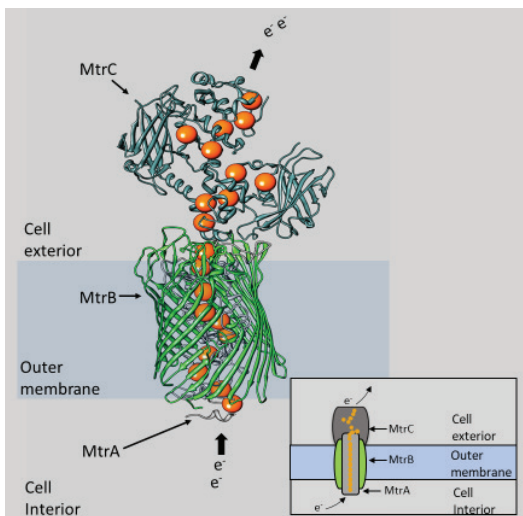
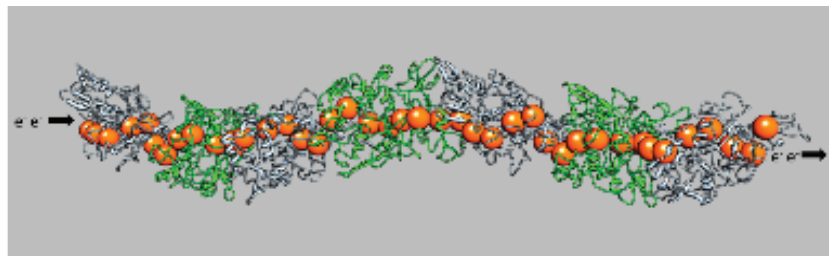

Figure 3. The MTR complex of *Shewanella*. The iron atoms (orange spheres) form a chain extending across the complex like beads on a string. The complex is formed by three proteins MtrC, MtrB and MtrA. As shown by the inset, the iron-containing MtrA sits inside a tube formed by MtrB. The structure, metal wrapped in polymer, is a molecular version of the wires found in phones, TVs etc!

Figure 4. (below) The OmcS biomolecular wire *Geobacter*. Many protein units assemble to arrange their iron atoms (orange spheres) as a long chain that extends away from the bacteria.



## MFCs - powering remote sensors and wastewater treatment

Increasing global demand for electricity, greater need for renewable energy combined with advances in technology and biochemistry, reignited interest in MFC research in the 80s and

90s. MFC prototypes are now being tested in a wide variety of industries, including wastewater treatment and hydrogen fuel production. There is also a lot of interest in using MFCs to run low-power sensors in remote areas. For instance, researchers replaced a battery powered temperature data logger in the Palouse River, Washington, with one powered by a MFC. The anode was buried in the sediment of the river and utilised the activity of anaerobic bacteria that naturally grow there to produce a small current to charge a capacitor, which then powered the thermometer. One of the main advantages of using MFCs over traditional batteries or power sources, is that bacteria are self-replicating and so in theory should not require maintenance to be carried out in hard to reach environments.

MFCs have also been utilised for wastewater treatment in various industries by companies such as Cambrian Innovation and Aquacycl offering transition to these greener alternatives. For example many processes in the beer brewing industry produce water contaminated with sugars, starch and proteins that need to be removed before water can be reused. These organic molecules fuel oxidative metabolic reactions in bacteria, and so MFCs can be used to break down water contaminants and produce bioenergy simultaneously. Scientists in Australia, working in collaboration with the beer maker Foster's, have been running trials since 2007 investigating the possibility of this technology. The primary target of the project was to reduce wastewater in an energy-efficient way, but they also showed that the 660-gallon fuel cell was able to generate 500 watts continuously (roughly enough to power a household). While this may not be a great amount of energy, water treatment consumes a huge amount of electricity and is very costly, so being able to process wastewater in a cost- and energy-efficient way is extremely valuable globally as we seek to conserve water and use less fossil fuels, especially in countries that experience drought or water shortages.

### **Algae-powered fuel cells**

Algae are aquatic unicellular or multicellular organisms that carry out photosynthesis to produce organic matter from sunlight. Algae have been widely used in MFCs at the cathode, as photosynthesis results in the production of oxygen which can be used for the reduction reaction. The algae can reuse and assimilate some of the waste materials from bacterial metabolism at the anode, increasing the self-sustainability of the MFC.

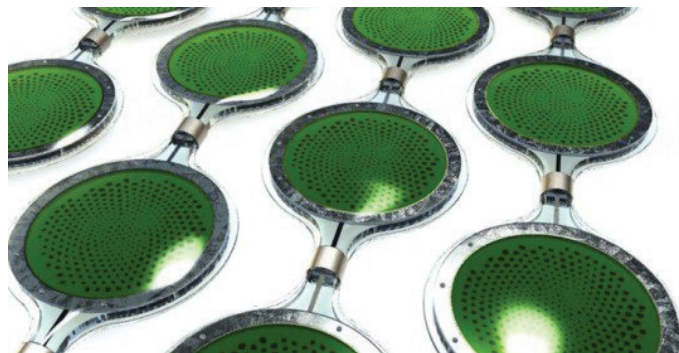

Algae can also be used directly at the anode to generate a current from the electrons produced during photosynthesis. The power output of these algae-powered fuel cells, also called biophotovoltaic devices, can be improved by using algae which have been mutated to have improved electron export mechanisms. Preliminary tests with these fuel cells show that they can power small electrical devices, such as alarm clocks and radios.

Although the power output is still far from being able to rival solar panels, producing renewable energy in remote locations is ideal for use in developing countries, for instance to charge mobile phones. It has also been shown that the algae can be immobilised in a gel, which would remove the need for algae to be kept in water and reduce the current limitations on weight and size, further widening possible applications.

## **Plant microbial fuel cells**

A further expansion of the MFC is the plant microbial fuel cell (pMFC), which sustains the bacterial colony at the anode on the organic matter secreted by plants during photosynthesis. This technology utilises the unique plant-bacterial relationship that is seen in the soil and can produce energy using plants that are being grown for food or found in public spaces. This means pMFCs are not competing for valuable land, as other renewable technologies such as wind and solar power are.

Plant-e, a company based in the Netherlands, have developed a number of pMFCs that can be installed on roofs and public spaces to power various processes. For instance, a 100 m<sup>2</sup> park can be installed with a mobile phone charging station or to create wi-fi hotspots. They've also designed a pMFC that can be installed on roundabouts to power streetlights. Such applications could have important consequences for the way we design green space in cities in the future and make a step towards reducing fossil fuel consumption.

While the idea of being able to power your house using the plants in your back garden is an exciting prospect, fuel cell technology involving biocatalysts still has a long way to go and the feasibility of producing that much power from a single fuel cell is highly questionable. There is also still a lot to explore about the type of materials, microbes and plants we use in fuel cells, as well as working out their optimal environmental and growth conditions. For now, MFC-based technology is best suited for low-power processes in remote areas or countries with poor electrical infrastructure, where it could make a significant impact on day-to-day lives.

## **Acknowledgements**

**The information given here was provided by Dr Paolo Bombelli (University of Cambridge) and Professor Julea Butt (University of East Anglia)**

**Find out more about Julea Butt's work here:**

**<https://www.juleab-lab.co.uk/>**

# What Can Viruses Do For You?

## Supplementary Information Sheet

### What are virus-like particles (VLPs)?

VLPs are non-infectious virus mimics that have had the genetic material responsible for replication and infection removed. VLPs have the same protein structure as the virus they are mimicking, and so can be used in vaccines to trigger immune responses in host organisms. The production of VLP vaccines is much cheaper, faster and safer than traditional vaccine production methods that require handling of the live virus.

### VLP production in plants

Plants can be used to produce large amounts of VLPs quickly and cheaply. Production is achieved through transient expression, where the genes encoding the viral proteins are introduced into a host plant and expressed within days. This method is much faster and cheaper than traditional stable transformation techniques, and is easily scaled up for commercial use.

Production of VLPs in plants also allows modifications to be made to the viral proteins that may assist in purification or the proteins from the plant, as well as altering stability and the type and number of antigens presents on the protein surface.

### Case study 1 - Producing a virus-free polio vaccine

#### **THE PROBLEM**

Polio is a viral infection caused by poliovirus. The majority of those infected do not experience any symptoms at all, but in serious cases the virus is able to infect nerve cells and destroy them. This can result in paralysis through loss of muscle function, and death if the virus spreads to the brain stem and destroys nerve cells involved in breathing and swallowing.

Polio can rapidly spread through a community if a local water source becomes contaminated with infected stool. Devastating outbreaks used to be commonplace during summer when swimming in potentially contaminated water supplies, such as rivers and lakes, was more popular. The introduction of routine vaccination in the 1950s and 1960s helped largely prevent these outbreaks in developed countries, however polio remained a huge problem in many areas of the world. Then, in 1988, the World Health Organisation (WHO), in collaboration with other charitable organisations,

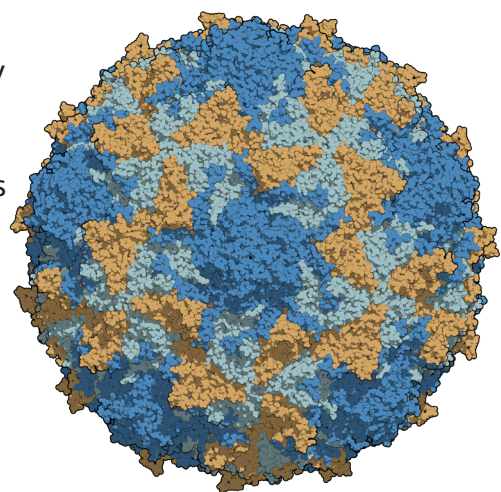

passed the Global Polio Eradication Initiative, which aimed to completely eradicate polio by the year 2000. The campaign was mostly successful, and to date 99.9% has been eradicated. Remaining cases are concentrated along the border between Pakistan and Afghanistan, and have proven difficult to extinguish due to socioeconomic problems hindering access to vaccination.

### ***THE CURRENT SOLUTION***

The oral polio vaccine first came into use in the early 1960s and quickly became the popular prevention method, especially in developing countries, due to the ease with which it can be administered and its affordability. The oral vaccine uses a weakened, or attenuated form of the virus, which is given to patients as a liquid drop in the mouth. After administration, the weakened virus has an incubation period in the intestine, where it replicates and can pass out in the patients excretion. In areas of poor sanitation, the virus is then passed onto others. For communities with a high vaccination rate this is not a problem and can even confer 'passive immunisation' to others. However, in rare cases, where the vaccination rate is low, the excreted virus can circulate and accumulate mutations and develop into a paralysing strain. This can lead to vaccine-derived polio and is one of the contributing factors to polio's persistence to date.

Due to the risks associated with the oral vaccine, attempts are being made to phase it out and replace it with the injectable vaccine, which uses a non-infectious, dead form of the virus. However, the price and availability of injectable vaccine remains a major barrier to this transition, with the injectable vaccine costing \$0.85 per dose, compared to \$0.25 for the oral vaccine. Producing a dead form of the virus also demands handling a live form of the virus during the production process, and so also propagates the global persistence of polio. As such, if a cheaper and safer version of the injectable vaccine could be produced, this might help eradicate the final 0.1% of polio.

### ***THE NEW SOLUTION - VLPs FOR VIRUS-FREE POLIO VACCINES***

A collaborative project based at the University of Leeds,



Title page image credits:

Strictosidine from periwinkle. Sarah O'Connor and Andrew Davis, NRP Image Library.

Streptomyces coelicolor. Mervyn Bibb and Andrew Davis, NRP Image Library.



This work was kindly supported by Biotechnology and Biological Science Research Council (BBSRC).



OpenPlant would like to thank all those who contributed to the production of the Synbio 4 Schools booklet. Special thanks to Miss Camilla Stanton who played a key role in the production of this booklet.



[www.openplant.org/](http://www.openplant.org/)



Norwich Research Park, Colney Lane, Norwich, NR4 7UG

